

# PVC insert tube (gasket) glazing system



Since 1979



## Descriptions: Flexible PVC gaskets profile

Applications: Intended for use in insertion of aluminum profile for resistance to air and water penetration of window and door gasket glazing systems.

**Colour:** Generally manufactured in black, but can be made to other colours upon client request.

**Temperature:** up to 70°C

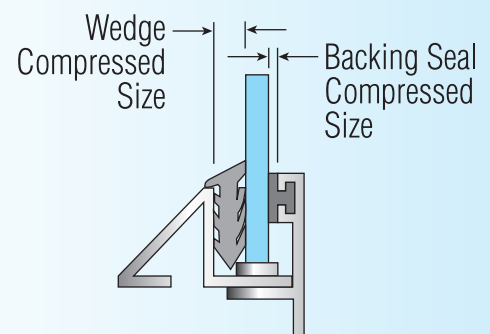

**PVC backing seals**

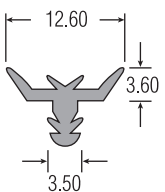

**PVC specialist seals**

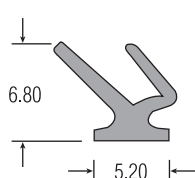

**PVC wedges**

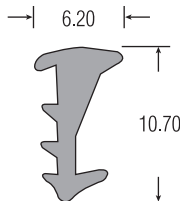

**PVC channel**

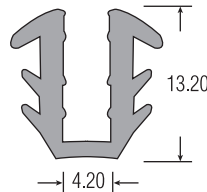

**PVC SP lines**

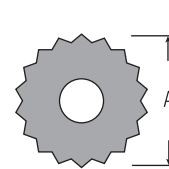

**PVC setting block**

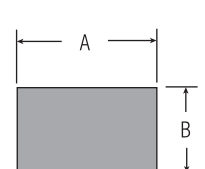

All dimensions in mm.